

snom 320

VoIP Business Phone



Quick Installation Kurzanleitung

Note to the reader

This is a quick guide to the installation and operation of the snom 320. The full manual is available on our web page, www.snom.com.

© 2005 snom technology Aktiengesellschaft.

All Rights Reserved. This document is supplied by snom technology AG. No part of this document may be reproduced, republished or retransmitted in any form or by any means whatsoever, whether electronically or mechanically, including, but not limited to, by way of photocopying, recording, information recording or through retrieval systems, without the express written permission of snom technology AG.

snom technology AG reserves the right to revise this document and make changes at any time and without the obligation to notify any person and/or entity of such revisions and/or changes.

Product specifications contained in this document are subject to change without notice.

Table of Contents

Note to the reader	2
Installation	5
Delivery Content	5
Safety Information.....	5
Power supply.....	5
Setting up the Phone.....	6
Wall Mounting	6
Cleaning.....	10
Connecting the phone	11
Keypad	13
Initialization.....	17
Booting	17
Selecting the language	17
DHCP Configuration.....	17
Setting the IP Address.....	18
Setting the Netmask	18
Setting the IP Gateway.....	18
Setting the DNS Server	19
Selecting the Tone Scheme	19
Selecting the Timezone.....	19
Logging on the first account	20
Index	23

Installation



Delivery Content

Please check whether the delivery contains the following parts:

- The base unit with display and keypad
- The handset
- The handset cable
- The power supply (optional)

Safety Information



Please read the following safety notices before installing or using your snom phone. They are crucial for the safe and reliable operation of the device.

Power supply

You have two options for providing the snom 320 with power:

- An external power supply (5 V)
- Power feeding over the network cable (IEEE 802.3af compatible)

If you want to use an external power supply, use the one that is included in the package. Other power supplies may cause damage to the phone, affect its behavior or induce noise.

Setting up the Phone

Your snom 320 is delivered with the footstand attached to the phone's bottom shell (shaded gray in Fig. 1). Place the snom 320 on an even, horizontal surface that gives the rubber pads a secure grip. Do not place it on carpets or other materials containing fibers that could block the air vents and cause overheating.

After connecting the phone (see chapter *Connecting the Phone*, below), clip the cords into the appropriate slots on the footstand or, in the case of the handset cord, on the bottom shell of the phone (Fig. 2).

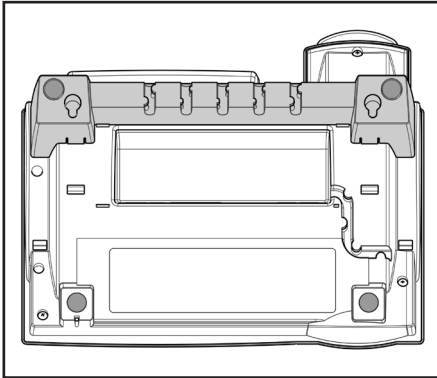

Fig. 1

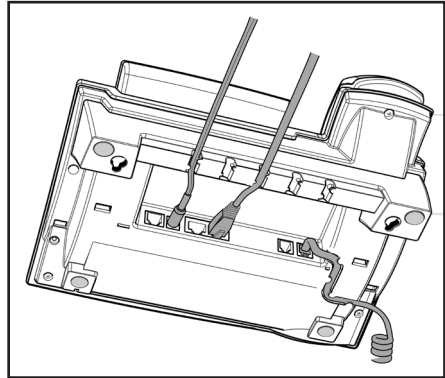

Fig. 2

Wall Mounting

It is also possible to mount the snom 320 on the wall. In order to do this, you detach the footstand from the bottom shell and attach it in the appropriate position for wall mounting, as described in steps 1 through 6, below.

- 1** Turn the phone upside down (Fig. 3). Please, ensure that you do not damage the display and/or its hinge and that you do not drop the receiver. You may want to hold the phone in your lap or have a second person hold it.

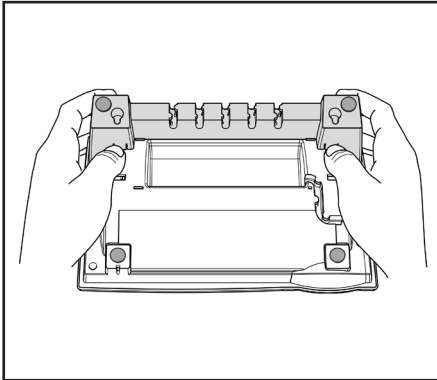

Fig. 3

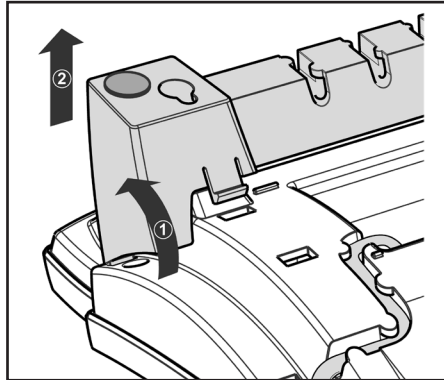

Fig. 4

- 2** Lightly press the snap-fits of the footstand inwards (Fig. 3) and, at the same time, tilt the footstand backwards and lift it from its anchorage in the mounting holes (Fig. 4).
- 3** Rotate the footstand 180° around its vertical axis.
- 4** Make sure that the handset cord has been clipped correctly into the groove on the bottom shell of the phone, as shown in Figs. 4 and 6. Failure to clip the cord into the groove will result in damage to the cord when the footstand is attached in the position for wall mounting.

- 5** Insert the outside, rear snap-fits into the mounting holes on the bottom shell (Fig. 5, arrow no. 1). Tilt the footstand forward and downward until the snap-fits snap into place in the mounting holes. **Please, make sure that the four snap-fits have securely snapped into the holes before mounting the phone on the wall.**

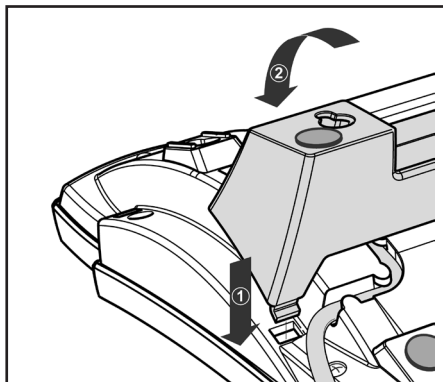

Fig. 5

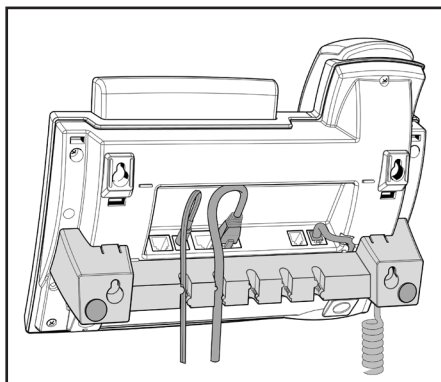

Fig. 6

- 6** The slots on the footstand for the various cords can also be used when the phone is mounted on a wall. After connecting the phone (see chapter *Setting up the Phone*, above), form the cords into loops and gently press the long ends into the slots on the footstand. The loops should not be too big, so that they will not hamper the secure mounting of the phone on the wall, and not too small, so that the cords will not be bent or broken (Fig. 6).

The delivery includes a template to be used for marking the position of the holes to be drilled in the wall.

(Use wall plugs, if necessary, and screws with half-round head profiles (diameters of screws $d_{max} = 4.5 \text{ mm}$ (0.175"), diameters of heads $d_{max} = 8.5 \text{ mm}$ (0.3315").

The screws must protrude approx. 0.5 cm (0.195") from the wall for easy wall mounting of the phone.

Adjusting the Handset Rest

The speaker of the handset has a small, rectangular indentation that fits over the rounded end of the plastic tab inserted into a slot on the top shell of the phone. When the phone is mounted on the wall, the handset must be placed on this rounded end to ensure that it will not fall off.

Slide the tab out of the slot, as shown in Fig. 7, rotate it 180°, and slide it back into the slot, as shown in Fig. 8.

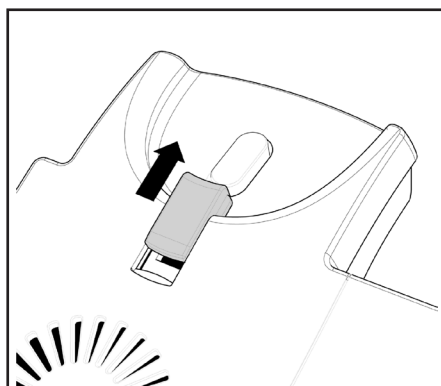

Fig. 7

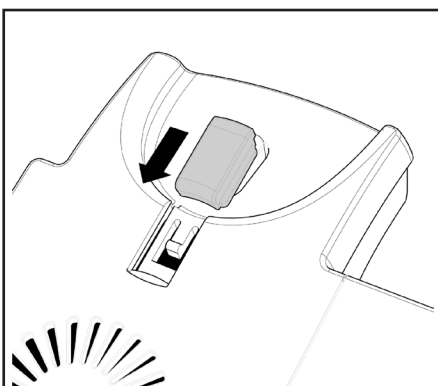

Fig. 8

Adjusting the Position of the Display

The position of the snom 320's display is adjustable up to an angle of 45° (Figs. 9 and 10).

Hold down the phone with one hand and adjust the display with your other hand. Do not use too much force and do not pull, wrench, or twist the display as this might damage or break the hinges.

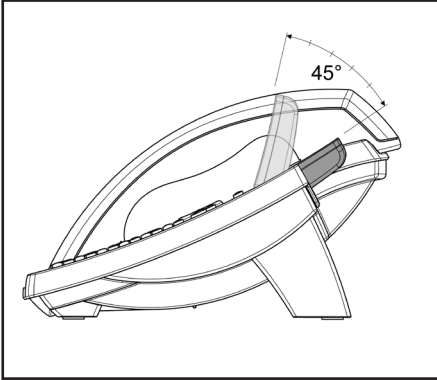

Fig. 9

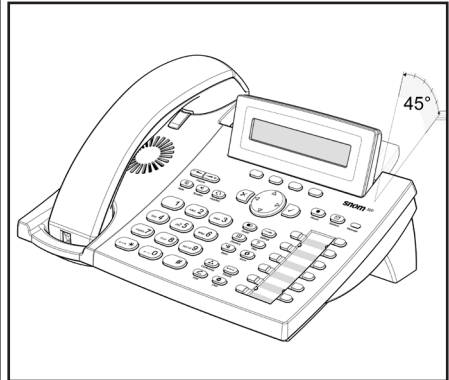

Fig. 10

Cleaning

To clean the snom 320, use an anti-static cloth. Please avoid cleaning liquids as they might damage the surface or the internal electronics of the phone.

Connecting the phone



First connect one end of the handset cable to the handset and then to the jack labeled "☎" on the left-hand side of the phone's bottom.

Next plug the Ethernet (network) cable into the RJ45 connector labeled "NET", and plug the other end into the network side to establish a data link. The second RJ45 connector, labeled "PC", is for daisy-chaining further Ethernet devices without the need for a second Ethernet connection line.

If you are using an external power supply, please insert the plug of the power supply into the connector labeled "DC 5V" next to the data line and hook up the casing into the mains.

If you want to use a headset, it can be connected to the audio jack labeled "🎧" on the bottom side of the snom 320.

Clip the cords into the appropriate slots on the footstand or, in the case of the handset cord, on the bottom shell of the phone (see Fig. 1 in the chapter *Setting up the phone*, above).



Keypad



The numeric keypad with the keys 0 to 9, *, and # is used to enter digits and letters. Depending on the operating mode, different actions can be performed (see the table below):

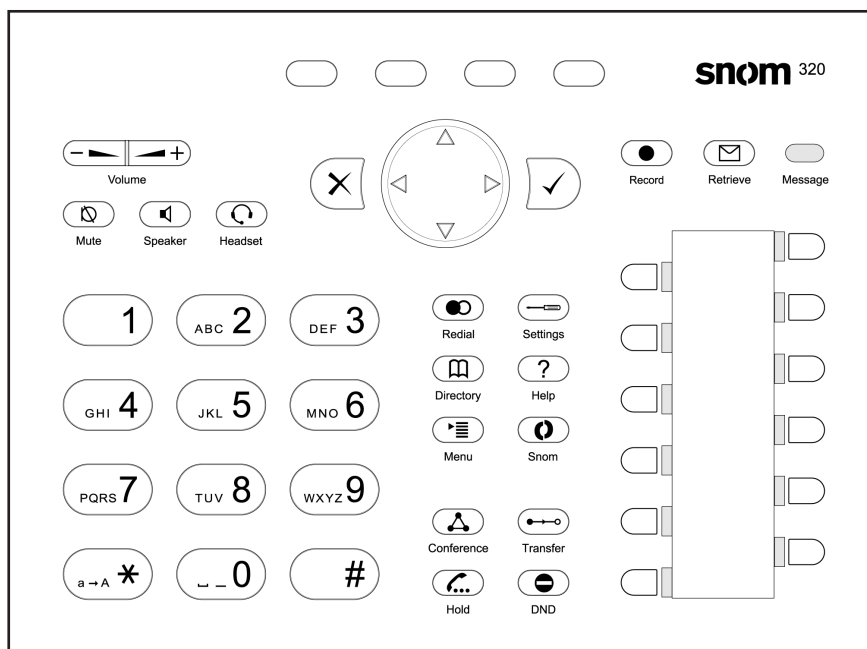

- Entry of digits only (e.g., when dialing a phone number)
- Typing in letters and digits by pressing the keys repeatedly (similar to a cellular phone), etc.















Use the  key to call up the menu. To cancel actions or input, use the CANCEL key . The ENTER key  confirms actions, selections and inputs. For navigation, use the large round navigation key in the middle.

Depending on the operating mode, the keys can have context-specific meanings which are described in the manual.

















The four soft keys located below the display are context-sensitive function keys. Their current mapping is depicted with texts in the bottom line on the display.

The twelve keys on the right with LEDs  /  next to them are programmable function keys onto which different functionalities can be mapped.

The keys of the numeric block in different operating modes:

Key	Digits	Lower case	Upper case
	0	(SPC)_0	(SPC)_0
	1	. @ 1 , ? ! - /(:);&%*# += <=> \$ []	. @ 1 , ? ! - /(:);&%*# += <=> \$ []
	2	abc2	ABC2
	3	def3	DEF3
	4	ghi4	GHI4
	5	jkl5	JKL5
	6	mno6	MNO6
	7	pqr7\$	PQRS7\$
	8	tuv8	TUV8
	9	wxyz9	WXYZ9
	"#" or "." after t i m e out	Number guessing	
	*	Toggles upper and lower case	

Additionally, the following keys are available:

Key	Description
	Mute microphone on/off
	Casing speaker on/off
	Adjust volume (lower/higher)
	Open phone book
	Info menu
	Menu
	Redial
	Settings menu
	XML add-on (planned)
	Establish 3-party conference
	'Do not disturb' mode on/off
	Call hold/unhold
	Call transfer
	Record a call (with server support only!)
	Connect to Mailbox
	LED for MWI (message waiting indication)



Initialization



Booting

The booting process comprises a series of different configuration steps that set up the phone for future use by any user.

Selecting the language

The default language setting is English. After startup the phone offers you the option to select the language of your choice. To change to a different language, use the  or  keys and press  to confirm.

```
Select Language:
←      English      →
```

DHCP Configuration

If your network supports DHCP, press  when this screen appears:

```
Are you using DHCP?
*On                      Off
```

The phone has a built-in DHCP client. It will receive an IP address and other network-related settings (Netmask, IP gateway, DNS server) from the DHCP server.

If your network does not support DHCP, press  when the above screen appears. The user will subsequently be asked for the following settings:





Setting the IP Address

The user can provide a static IP address for the phone if DHCP is not used. A valid IP address appropriate to the network in which the phone is being used can be provided.

```
IP Address:
092.168.139.212
```

4

The following edit functions for IP address editing are available via the navigation key:

-  Clear IP address
-  Move cursor to the right
-  Backspace and delete sign to the left of the cursor
-  Move cursor to the left
-  Confirm input

Setting the Netmask

Similarly, the user will be asked to provide a Netmask. After entering the information, confirm with .

```
Netmask:
055.255.0 .0
```

Setting the IP Gateway

If a valid Netmask has been provided, the user will be asked for the IP address of the IP gateway. After entering the information, confirm with .

```
IP Gateway:
92.168.0 .1
```

Setting the DNS Server

The last item for this series of network-related configurations is the IP address for the DNS server. After entering the information, confirm with .

```
DNS Server:
92.168.0 .9
```

Selecting the Tone Scheme

The user will then be asked for the tone scheme to be used on the phone. After moving the cursor with the navigation key to the tone scheme you wish to use, confirm with .

```
Select Dialtone:
+      Australia      +
```

Selecting the Timezone

The timezone to be used on the phone can also be selected by moving through the different timezone options available in the menu and pressing  to confirm your selection.

```
Select Timezone:
+  -10: USA (Honolulu)  +
```

If the settings explained above are set up properly, the phone will ask for the first account registration.

Logging on the first account

If no number is assigned to the phone yet, you will be prompted to type in your account name. Confirm by pressing the key.

```
Account:                abc
█
```

4

The phone will then try to guess the correct registrar. If the registrar shown on the display is incorrect, please correct the information. The screen might show something like this:

```
Registrar:             abc
intern.snom.de█
```

Confirm by pressing . You will then be asked whether you want to use ENUM.

```
Use ENUM?
On                Off
```

Press if you wish to use ENUM or , if you do not. If you have chosen ENUM, you will be asked for the country code (e.g., 1 for the US) and the area code (e.g., 802 for Vermont). ENUM means that a conventional E.164 number (normal phone numbers) is mapped to a SIP URI so that a pure IP call can be started instead of an IP/PSTN call. Regarding ENUM see also our white paper „ENUM on snom phones“.

```
Country Code:
█
```

```
Area Code:
█
```

Enter the codes and confirm with  each time.

The phone tries to register your given account name at the given registrar. The idle screen appears. Your registration has been successful if the identity you have just configured is shown in brackets in the top line. If, however, the letters „NR“ are shown instead, the registration has not been successful.



```
4/28 (447) 2 57PM
DND PhoneBk Reg CallLog
```

When the registration has been successful, the time and date are also shown on the display.

**The complete manual is available on our web page,
www.snom.com.**



Index

A

Account 20
Adjust volume 15

B

Booting 17

C

Call hold/unhold 15
Call transfer 15
CANCEL key 13
Casing speaker 15
Cleaning 10
Conference 15
Connecting the phone 6, 11
Connect to Mailbox 15

D

DHCP 17
Display 9
DNS Server 19
Do not disturb 15

E

ENTER key 13

F

Forwarding. *see* Call Transfer

H

Handset rest 9
Help 15

I

Installation 5
IP Address 18
IP Gateway 18

K

Keypad 13

L

Language 17
LEDs 14
LED for MWI 15

M

Main menu 15
Manual 21

MENU key 13
Mute microphone 15

N

Netmask 18
Numeric block 14
numeric keypad 13

O

Open phone book 15

P

Power supply 5
 External power supply 5
 Power feeding 5

R

Record a call 15
Redial 15

S

Safety 5
Safety Information 5
Settings menu 15
Setting up the Phone 6
Soft keys 14

T

Timezone 19
Tone scheme 19

W

Wall mounting 6

Copyright © 2005 snom technology AG. All rights reserved. snom® is a registered trademark of snom technology AG and affiliates in Germany, U.S.A. and certain other countries. Other trademarks or registered trademarks mentioned in this document are the property of their respective manufacturers or owners.